

Extended Red, High Sensitivity, Multialkali Photocathode 28mm (1-1/8 Inch) Diameter, 9-Stage, Side-On

FEATURES

- **Wide Spectral Response**
 - R928 185 to 900 nm
 - R955 160 to 900 nm
- **High Cathode Sensitivity**
 - Luminous 250 μ A/lm
 - Radiant at 400nm 74mA/W
- **High Anode Sensitivity (at 1000V)**
 - Luminous 2500A/lm
 - Radiant at 400nm 7.4×10^5 A/W
- **Low Drift and Hysteresis**

The R928 and R955 feature extremely high quantum efficiency, high current amplification, good S/N ratio and wide spectral response from UV to near infrared. The R928 employs a UV glass envelope and the R955 has a fused silica envelope for UV sensitivity extension.

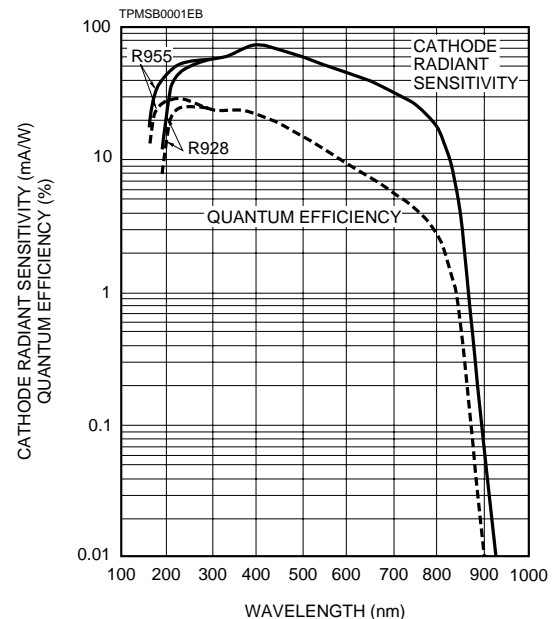
The R928 and R955 are well suited for use in broad-band spectrophotometers, atomic absorption spectrophotometers, emission spectrophotometers and other precision photometric instruments.



GENERAL

Parameter	Description/Value	Unit
Spectral Response		
R928	185 to 900	nm
R955	160 to 900	nm
Wavelength of Maximum Response	400	nm
Photocathode		
Material	Multialkali	—
Minimum Effective Area	8 × 24	mm
Window Material		
R928	UV glass	—
R955	Fused silica	—
Dynode		
Secondary Emitting Surface	Multialkali	—
Structure	Circular-cage	—
Number of Stages	9	—
Direct Interelectrode Capacitances		
Anode to Last Dynode	Approx. 4	pF
Anode to All Other Electrodes	Approx. 6	pF
Base	11-pin base JEDEC No. B11-88	—
Weight	Approx. 45	g
Suitable Socket	E678-11A (option)	—
Suitable Socket Assembly	E717-21 (option)	—

Figure 1: Typical Spectral Response



PHOTOMULTIPLIER TUBES R928, R955

MAXIMUM RATINGS (Absolute Maximum Values)

Parameter	Value	Unit
Supply Voltage		
Between Anode and Cathode	1250	Vdc
Between Anode and Last Dynode	250	Vdc
Average Anode Current	0.1	mA
Ambient Temperature	-80 to +50	°C

CHARACTERISTICS (at 25°C)

Parameter	R928			R955			Unit
	Min.	Typ.	Max.	Min.	Typ.	Max.	
Cathode Sensitivity							
Quantum Efficiency at Peak Wavelength	—	25.4 (at 260nm)	—	—	29.0 (at 220nm)	—	%
Luminous ^B	140	250	—	140	250	—	μA/lm
Radiant at 194nm	—	18	—	—	43	—	mA/W
254nm	—	52	—	—	56	—	mA/W
400nm	—	74	—	—	74	—	mA/W
633nm	—	41	—	—	41	—	mA/W
852nm	—	3.5	—	—	3.5	—	mA/W
Red/White Ratio ^C	0.2	0.3	—	0.2	0.3	—	—
Blue ^D	—	8	—	—	8	—	μA/lm-b
Anode Sensitivity							
Luminous ^E	400	2500	—	400	2500	—	A/lm
Radiant at 194nm	—	1.8 × 10 ⁵	—	—	4.3 × 10 ⁵	—	A/W
254nm	—	5.2 × 10 ⁵	—	—	5.6 × 10 ⁵	—	A/W
400nm	—	7.4 × 10 ⁵	—	—	7.4 × 10 ⁵	—	A/W
633nm	—	4.1 × 10 ⁵	—	—	4.1 × 10 ⁵	—	A/W
852nm	—	3.5 × 10 ⁴	—	—	3.5 × 10 ⁴	—	A/W
Gain ^E	—	1.0 × 10 ⁷	—	—	1.0 × 10 ⁷	—	—
Anode Dark Current ^F							
After 30 minute Storage in the darkness	—	3	50	—	3	50	nA
ENI(Equivalent Noise Input) ^H	—	1.3 × 10 ⁻¹⁶	—	—	1.3 × 10 ⁻¹⁶	—	W
Time Response ^E							
Anode Pulse Rise Time ^I	—	2.2	—	—	2.2	—	ns
Electron Transit Time ^J	—	22	—	—	22	—	ns
Transit Time Spread (TTS) ^K	—	1.2	—	—	1.2	—	ns
Anode Current Stability ^L							
Current Hysteresis	—	0.1	—	—	0.1	—	%
Voltage Hysteresis	—	1.0	—	—	1.0	—	%

NOTES

A: Averaged over any interval of 30 seconds maximum.

B: The light source is a tungsten filament lamp operated at a distribution temperature of 2856K. Supply voltage is 100 volts between the cathode and all other electrodes connected together as anode.

C: Red/White ratio is the quotient of the cathode current measured using a red filter(Toshiba R-68) interposed between the light source and the tube by the cathode current measured with the filter removed under the same conditions as Note B.

D: The value is cathode output current when a blue filter(Corning CS-5-58 polished to 1/2 stock thickness) is interposed between the light source and the tube under the same condition as Note B.

E: Measured with the same light source as Note B and with the voltage distribution ratio shown in Table 1 below.

Table 1: Voltage Distribution Ratio

Electrode	K	Dy1	Dy2	Dy3	Dy4	Dy5	Dy6	Dy7	Dy8	Dy9	P
Distribution Ratio	1	1	1	1	1	1	1	1	1	1	1

Supply Voltage : 1000Vdc

K : Cathode, Dy : Dynode, P : Anode

F: Measured with the same supply voltage and voltage distribution ratio as Note E after removal of light.

G: Measured at a supply voltage adjusted to provide an anode sensitivity of 100 A/lm.

H: ENI is an indication of the photon-limited signal-to-noise ratio. It refers to the amount of light in watts to produce a signal-to-noise ratio of unity in the output of a photomultiplier tube.

$$ENI = \frac{\sqrt{2q \cdot I_{db} \cdot G \cdot \Delta f}}{S}$$

where q = Electronic charge (1.60 × 10⁻¹⁹ coulomb).

I_{db} = Anode dark current(after 30 minute storage) in amperes.

G = Gain.

Δf = Bandwidth of the system in hertz. 1 hertz is used.

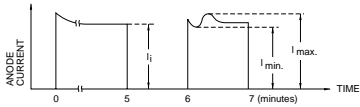
S = Anode radiant sensitivity in amperes per watt at the wavelength of peak response.

I: The rise time is the time for the output pulse to rise from 10% to 90% of the peak amplitude when the entire photocathode is illuminated by a delta function light pulse.

J: The electron transit time is the interval between the arrival of delta function light pulse at the entrance window of the tube and the time when the anode output reaches the peak amplitude. In measurement, the whole photocathode is illuminated.

K: Also called transit time jitter. This is the fluctuation in electron transit time between individual pulses in the signal photoelectron mode, and may be defined as the FWHM of the frequency distribution of electron transit times.

L: Hysteresis is temporary instability in anode current after light and voltage are applied.



TPMSB0002EA

Figure 2: Anode Luminous Sensitivity and Gain Characteristics

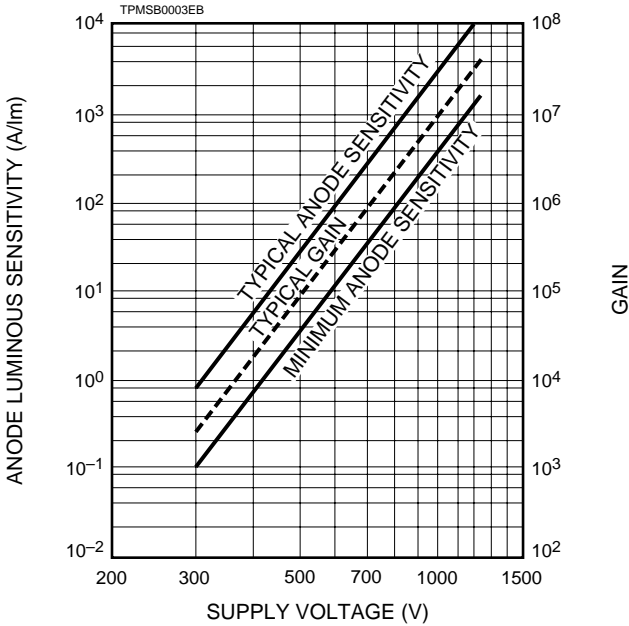
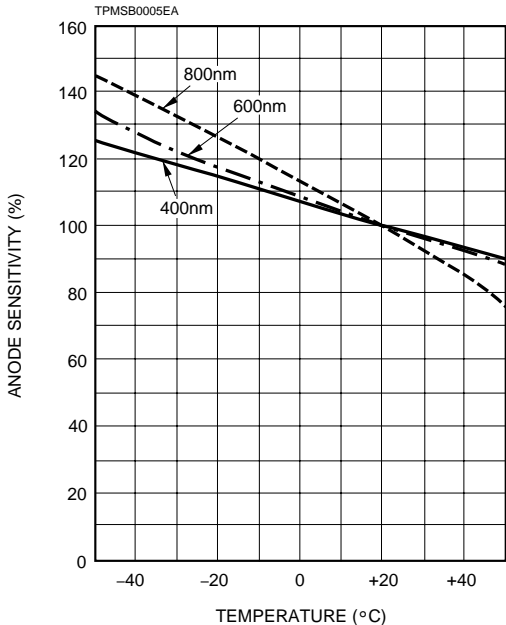


Figure 4: Typical Temperature Coefficient of Anode Sensitivity



$$\text{Hysteresis} = \frac{I_{\text{max.}} - I_{\text{min.}}}{I_i} \times 100(\%)$$

(1) Current Hysteresis

The tube is operated at 750 volts with an anode current of 1 micro-ampere for 5 minutes. The light is then removed from the tube for a minute. The tube is then re-illuminated by the previous light level for a minute to measure the variation.

(2) Voltage Hysteresis

The tube is operated at 300 volts with an anode current of 0.1 micro-ampere for 5 minutes. The light is then removed from the tube and the supply voltage is quickly increased to 800 volts. After a minute, the supply voltage is then reduced to the previous value and the tube is re-illuminated for a minute to measure the variation.

Figure 3: Typical Time Response

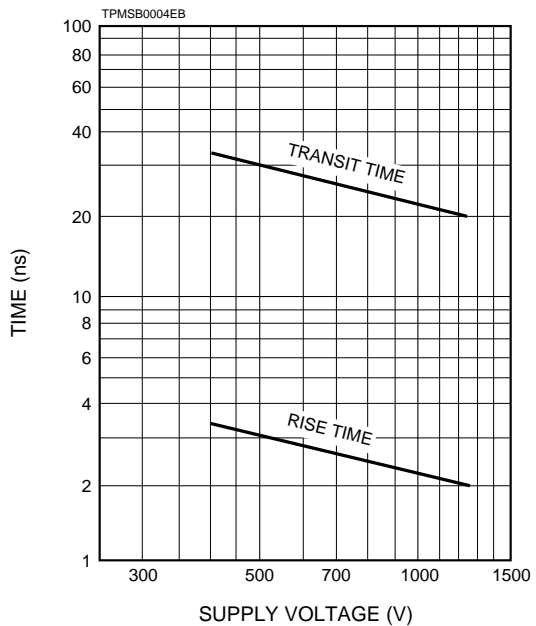
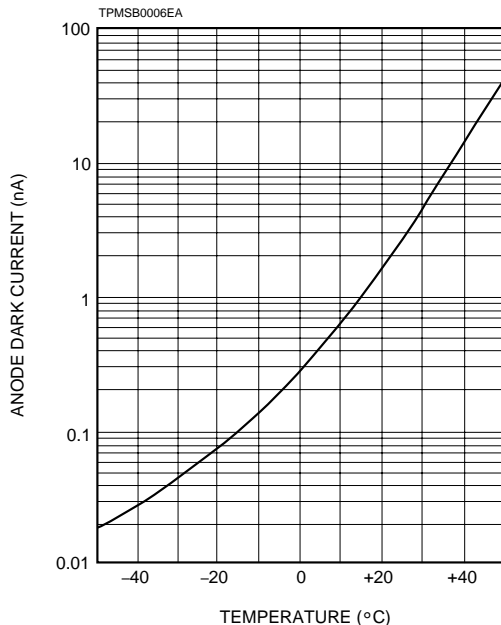
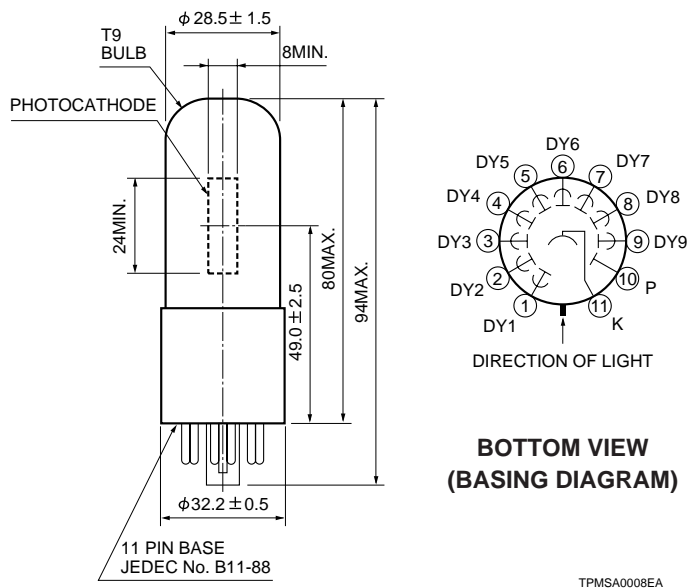


Figure 5: Typical Temperature Characteristic of Dark Current (at 1000V, after 30minute storage)



PHOTOMULTIPLIER TUBES R928, R955

Figure 6: Dimensional Outline and Basing Diagram (Unit : mm)



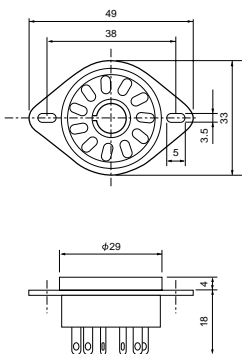
Hybrid Assembly of R928 H957-08

The H957-08 integrates on R928, a voltage-divider circuit, and a high voltage power supply into a compact magnetic shield case. It can be readily operated by input of 15Vdc.

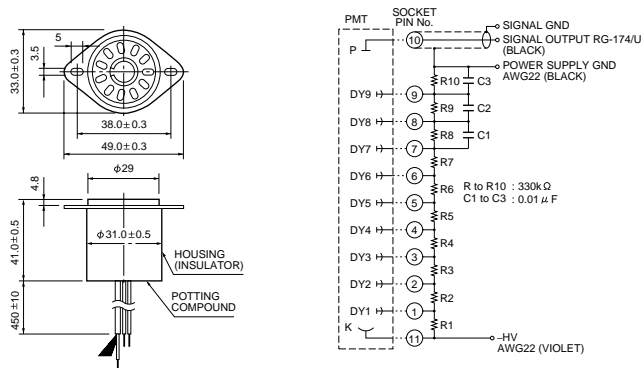


Figure 7: Optional Accessories (Unit : mm)

Socket (E678 - 11A)



D Type Socket Assembly E717-21



※Hamamatsu also provides C4900 series compact high voltage power supplies and C6270 series DP type socket assemblies which incorporate a DC to DC converter type high voltage power supply.

Warning—Personal Safety Hazards
Electrical Shock—Operating voltages applied to this device present a shock hazard.

HAMAMATSU

HAMAMATSU PHOTONICS K.K., Electoron Tube Center

314-5, Shimokanzo, Toyooka-village, Iwata-gun, Shizuoka-ken, 438-0193, Japan, Telephone: (81)539/62-5248, Fax: (81)539/62-2205

U.S.A.: Hamamatsu Corporation: 360 Foothill Road, Bridgewater, N.J. 08807-0910, U.S.A., Telephone: (1)908-231-0960, Fax: (1)908-231-1218

Germany: Hamamatsu Photonics Deutschland GmbH: Arzbergerstr. 10, D-82211 Herrsching am Ammersee, Germany, Telephone: (49)8152-375-0, Fax: (49)8152-2658

France: Hamamatsu Photonics France S.A.R.L.: 8, Rue du Saule Trapu, Parc du Moulin de Massy, 91882 Massy Cedex, France, Telephone: (33)1 69 53 71 00, Fax: (33)1 69 53 71 10

United Kingdom: Hamamatsu Photonics UK Limited: Lough Point, 2 Gladbeck Way, Windmill Hill, Enfield, Middlesex EN2 7JA, United Kingdom, Telephone: (44)181-367-3560, Fax: (44)181-367-6384

North Europe: Hamamatsu Photonics Norden AB: Färögatan 7, S-164-40 Kista Sweden, Telephone: (46)8-703-29-50, Fax: (46)8-750-58-95

Italy: Hamamatsu Photonics Italia: S.R.L.: Via Della Moia, 1/E, 20020 Arese, (Milano), Italy, Telephone: (39)2-935 81 733, Fax: (39)2-935 81 741

TPMS1001E06
MAY. 1997